

Mountain Bluff Collection Essential Rocking Chair

Assembly Guide

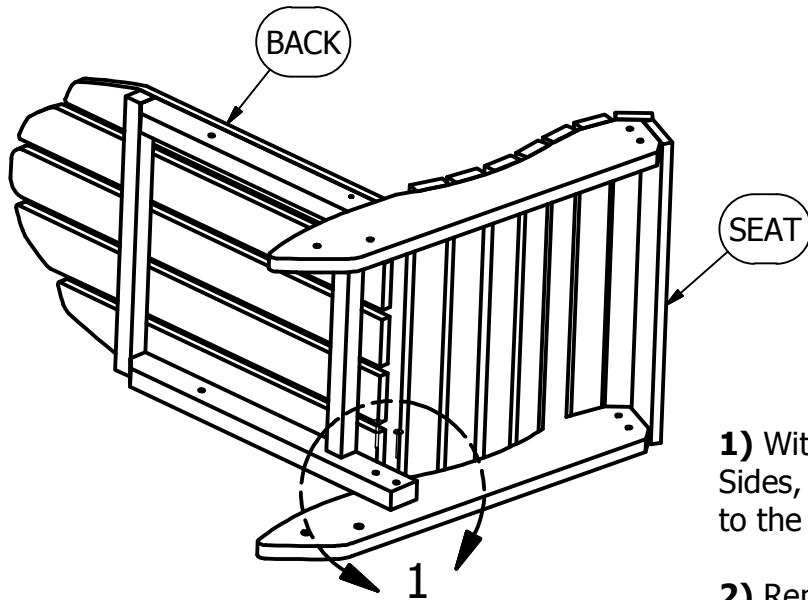
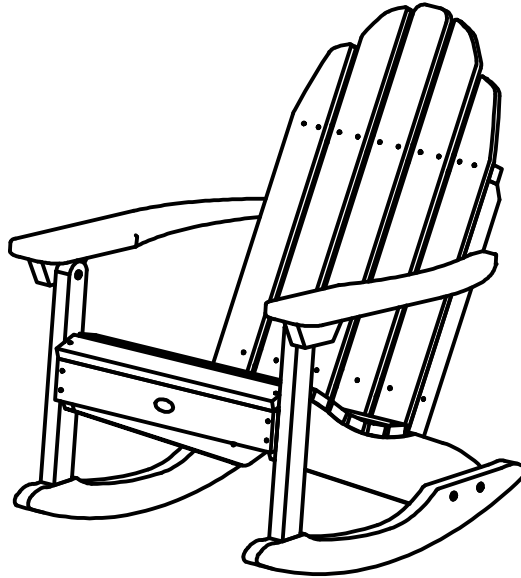
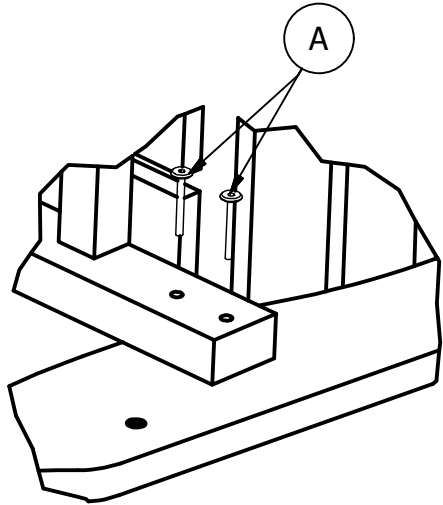

1) With the Back and Seat on Their Sides, Attach One Side of the Back to the Seat Using Two "A" Bolts.

2) Repeat on Other Side.

HARDWARE

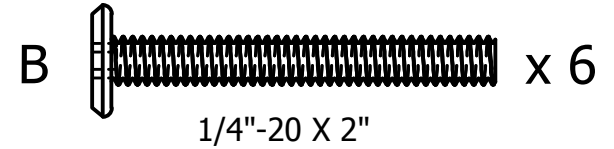
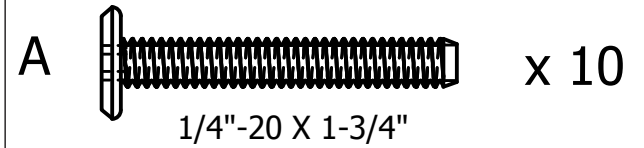

IMPORTANT!

DO NOT fully tighten the bolts until all bolts are started. Once all bolts are inserted, go back & tighten all the bolts.

Retain these instructions for future reference

INCLUDED TOOLS

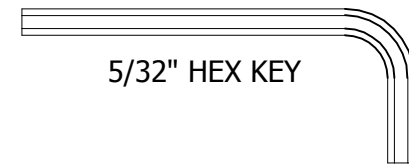

5/32" HEX KEY



ELK OUTDOORS
by **highwood**[®]

For information on Care and Cleaning or to register your ELK OUTDOORS product by *highwood*[®], please visit www.highwood-usa.com.

EO-ROC-CW2
09.05.2018

PAGE 1 OF 2

Mountain Bluff Collection Essential Rocking Chair

Assembly Guide

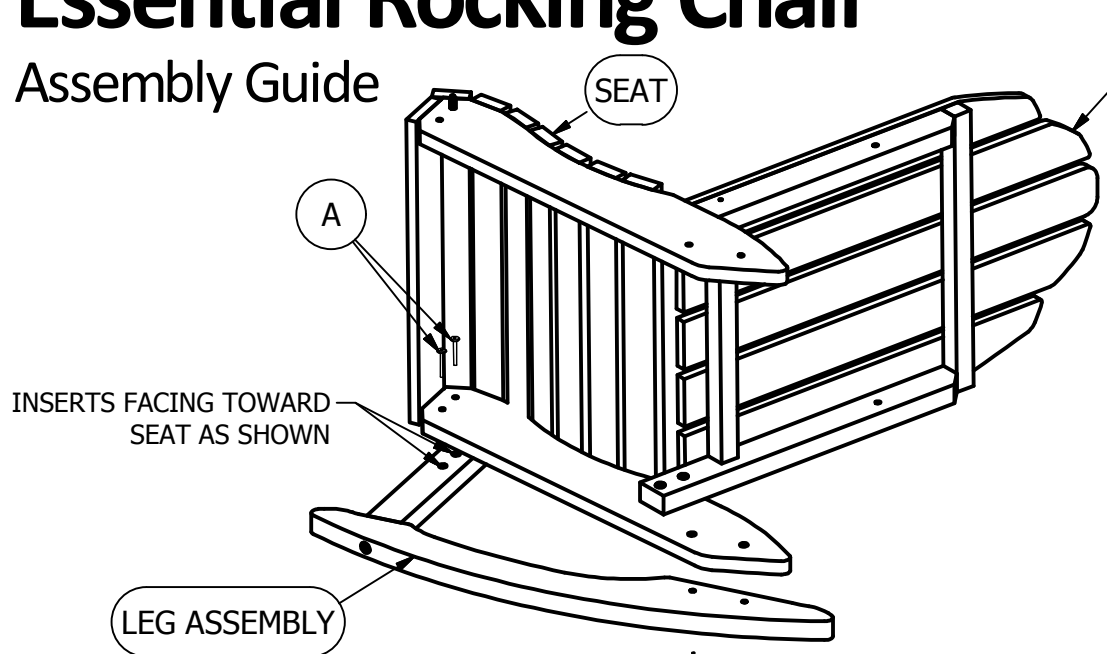

3) Attach Front of Leg Assembly to Seat Using Two "A" Bolts as Shown Above. Attach Back of Leg Assembly to Seat Using Two "B" Bolts as Shown Below.

4) Repeat on Other Side.

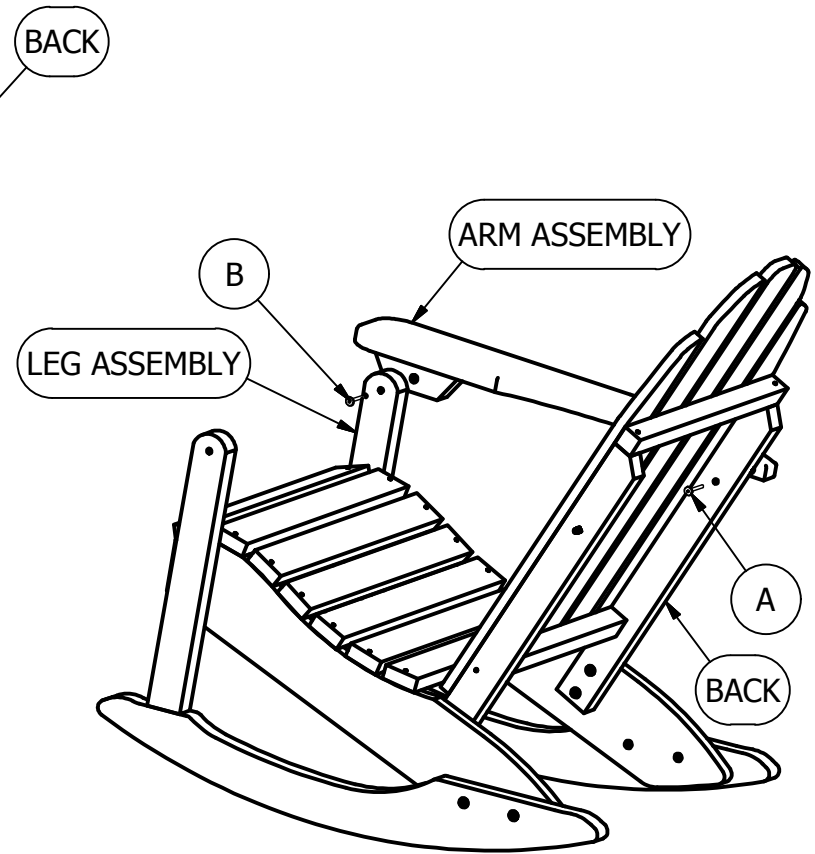
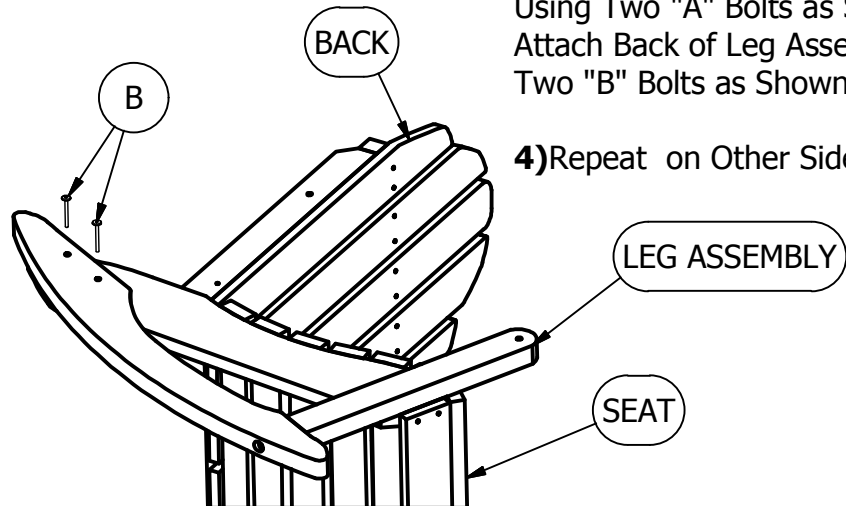

5) Attach Arm Assembly to Leg Using One "B" Bolt. Attach Arm Assembly to Back Using One "A" Bolt.

6) Repeat on Other Side.



ELK OUTDOORS
by **highwood**[®]

For information on Care and Cleaning or to register your ELK OUTDOORS product by *highwood*[®], please visit www.highwood-usa.com.

EO-ROC-CW2
09.05.2018

PAGE 2 OF 2